

# Product datasheet

High speed door  
Albany HS8010P

ASSA ABLOY

ASSA ABLOY Entrance Systems

The global leader in  
door opening solutions



# Copyright and Disclaimer Notice

Although the contents of this publication have been compiled with the greatest possible care, ASSA ABLOY Entrance Systems cannot accept liability for any damage that might arise from errors or omissions in this publication. We also reserve the right to make appropriate technical modifications/replacements without prior notice.

No rights can be derived from the contents of this document.

Color guides: Color differences may occur due to different printing and publication methods.

ASSA ABLOY, Besam, Crawford, Megadoor and Albany, as words and logos, are examples of trademarks owned by ASSA ABLOY Entrance Systems or companies within the ASSA ABLOY Group.

Copyright © ASSA ABLOY Entrance Systems AB 2006-2014.

No part of this publication may be copied or published by means of scanning, printing, photocopying, microfilm or any other process whatsoever without prior permission in writing by ASSA ABLOY Entrance Systems.

All rights reserved.

# Technical facts

## Features

Area of use:	Outside
Structure:	Galvanized steel
Max size: (W x H)*	5500 mm x 5500 mm
Colours:	8 standard colors - white, yellow, green, orange, red, gray, black, blue
Safety:	Photocells in side columns Flexible soft bottom edge including wireless edge activator Break-away and self-repair function
Options:	Different vision options are available. Colour of drum cover, side column cover, motor cover.

\* Other sizes available on request

## Performance

Operating speed:	Opening: up to 2,4 m/s ** Closing: 1,2 m/s
Wind load resistance	Class 3 (700 Pa (N/m <sup>2</sup> )) Class 4 (1000 Pa (N/m <sup>2</sup> )) for doors up to W 4000 mm x H 5500 mm
Water penetration:	Class 2 (50 Pa (N/m <sup>2</sup> ))
Air permeability	Class 1 (24 m <sup>3</sup> /m <sup>2</sup> /h at 50 Pa)
Thermal transmittance:	6,02 W/(m <sup>2</sup> K)
Lifetime expectations:	1.000.000 cycles
Temperature working range:	0 °C to +40 °C

\*\* Depending on door size

# Contents

Copyright and Disclaimer Notice .....	2
Technical facts .....	3
Contents .....	4
<b>1. Description .....</b>	<b>6</b>
1.1 General .....	6
1.1.1 Standard .....	6
1.1.2 Options .....	6
1.2 Door curtain .....	6
1.2.1 Construction .....	6
1.2.2 Material .....	6
1.2.3 Colours .....	7
1.2.4 Windows and vision panels .....	7
1.2.5 Insulated door curtain .....	7
1.2.6 Self repair system .....	7
1.2.7 Bottom edge .....	7
1.3 Side columns .....	8
1.3.1 General .....	8
1.3.2 Wind reinforcement .....	8
1.4 Header box .....	8
1.4.1 Fabric roll .....	8
1.4.2 Covers .....	8
1.5 Operating system .....	9
1.5.1 General .....	9
1.5.2 Operator .....	9
1.5.3 Door drive system .....	9
1.5.4 Control unit .....	9
1.5.5 Chain hoist .....	9
1.5.6 Access and automation .....	10
1.5.7 Monitoring systems .....	13
<b>2. Specifications .....</b>	<b>14</b>
2.1 Daylight width and height .....	14
2.2 Fabric specifications .....	14
2.3 Windows .....	14
2.3.1 Required Daylight Width .....	14
2.3.2 Required Daylight Height .....	14
2.4 Vision panels .....	15
2.4.1 400 mm vision panel .....	15
2.4.2 800 mm vision panel .....	15
2.5 Large windows .....	15
<b>3. CEN Performance .....</b>	<b>16</b>
<b>4. Building and space requirements .....</b>	<b>17</b>
4.1 Building preparations .....	17
4.1.1 Installation preparations .....	17
4.1.2 Electrical preparations .....	17
4.2 Space requirements .....	18

5. Service .....	19
<hr/>	
Index .....	20
<hr/>	

# 1. Description

## 1.1 General

The Albany HS8010P high speed door is designed for exterior openings in medium-sized heavy-duty operations. It protects your environment against draughts, humidity, dust and dirt. With fast opening and closing speed, the door improves your traffic flow, provides employee comfort, and saves energy.

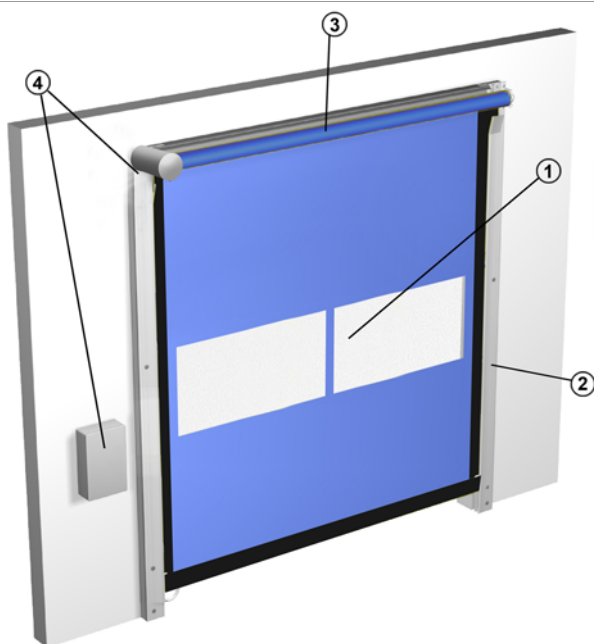

The Albany HS8010P high speed door has 4 primary parts:

- 1) Door curtain
- 2) Side columns
- 3) Header box
- 4) Operating system

### 1.1.1 Standard

The Albany HS8010P high speed door is supplied with the following specifications as standard:

Door curtain:	900 g/m <sup>2</sup> coloured PVC
Structure:	Galvanized steel
Side column:	Wind reinforcement 230 mm at the bottom
Safety:	Photocells in side columns Flexible soft bottom edge including wireless edge activator Break-away and self-repair function
Operation:	Operator + control unit
Colours:	8 standard colors - white, yellow, green, orange, red, gray, black, blue

### 1.1.2 Options

Albany provides a wide range of options and accessories to customise the Albany HS8010P high speed door to any customer's needs.

Header box:	Galvanised steel drum cover Galvanised steel operator cover
Side column:	Galvanised steel side column covers
Operation:	Access and Automation Monitoring System
Windows:	Small windows or; Vision panels or; Large windows
Insulated door curtain	Static insulation 2,41 W/m <sup>2</sup> K (max. 4500 mm x 4500 mm)

## 1.2 Door curtain

### 1.2.1 Construction

The door curtain is constructed from one single piece of PVC fabric. The door curtain rolls up above the door opening and requires little space.

#### Top

The top of the fabric is connected to a fabric roll, located in the header box above the door opening.

#### Bottom

The flexible bottom edge of the door curtain does not contain any stiffeners, making the door curtain completely safe as the curtain moulds itself in case a person is trapped below the closing door.

#### Side

The left and right sides of the door curtain are constructed with a patented retaining strap. If the door is hit by a vehicle, a part of this retaining strap is pulled out of the side column. The self repair function acts as a zipper to put the retaining strap back in the side column.

### 1.2.2 Material

#### Fabric type

- 900 g/m<sup>2</sup> colored PVC,
- high resistance

### 1.2.3 Colours

The Albany HS8010P high speed door is available in 8 standard colors fabric colours. The RAL-colours are as close as possible to the official RAL HR collection. Max. deviation is 1,0 DE.



RAL 1003



RAL 2004



RAL 3000



RAL 5002



RAL 6005



RAL 7035



RAL 9005

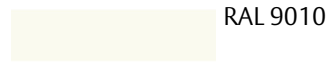

RAL 9010

### 1.2.4 Windows and vision panels

To increase the admission of daylight or to improve the visibility, the door curtain can be equipped with windows or vision panels. Windows have fixed sizes and are located on a pre-defined grid. A vision panel is always located on the full width of the door curtain with its centre height at the industry of standard 1600 mm.

#### Vision panel

#### Windows



### 1.2.5 Insulated door curtain

For an improved temperature management an insulated door curtain is available with static insulation of 2,41 W/m<sup>2</sup>K

- Max. 4500 mm x 4500 mm
- With drum cover headroom +650
- No windows
- Available colours:  
Yellow RAL 1003  
Red RAL 3000  
Blue RAL 5002  
Gray RAL 7035

### 1.2.6 Self repair system

The high speed doors are equipped with an automatic repair system. If a door is hit by a vehicle during operation, the resistant door curtain absorbs the impact and releases itself from its side guides without damage. The door reinserts itself automatically within the next open and close cycle. This unique feature makes the door crash-resistant without sustaining damage, reducing production downtime and maintenance.



### 1.2.7 Bottom edge

The bottom edge is a flexible bag that contains a wireless edge activator. When the door is hit by a vehicle, the curtain folds around the object and the contacts within the bottom edge make a closed circuit. The wireless signal is then sent to the operator to stop the door movement immediately.



## 1.3 Side columns

The side columns guide the door curtain up and down. This guidance is a plastic-to-plastic connection, which makes lubrication essential.

### 1.3.1 General

The side columns are part of the frame that also contains the header box. This frame is made of 3 mm thick galvanized steel tubes. The side columns are connected directly to the wall.

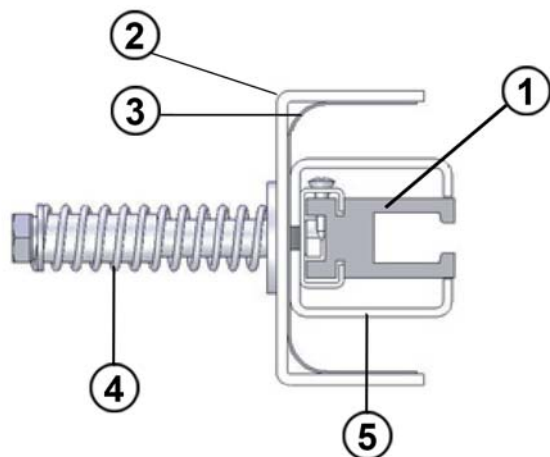

- 1) Low-friction polyethylene side guide inside a steel rail
- 2) Galvanized steel structure. U-channel 80 mm x 40 mm x 3 mm
- 3) Flexible rubber seal
- 4) Tension spring
- 5) Wind reinforcement (230 mm at bottom)

### 1.3.2 Wind reinforcement

At the bottom of the side columns, a wind reinforcement is installed around the side guide to increase the wind load resistance of the door. The bottom part of the door curtain is the most vulnerable to wind load. This reinforcement prevents that the curtain will be pulled out of the side guides.

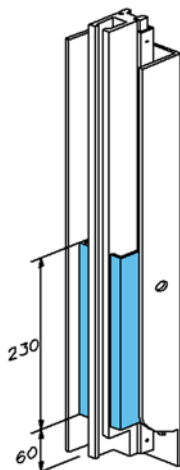

## 1.4 Header box

### 1.4.1 Fabric roll

The fabric roll is installed in the header box above the door curtain. Its function is to roll up the door curtain by means of a counterweight. A gear drive system forces the door curtain up and down the tracks.

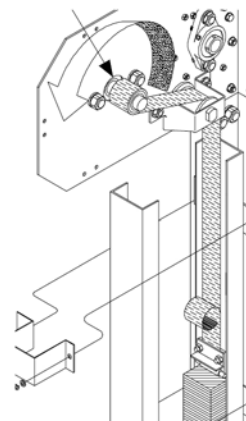

### 1.4.2 Covers

For use in dusty and dirty environments or for aesthetical reasons, an optional header box cover is available to enclose the fabric roll and/or the operator. Also the side columns can be equipped with covers.

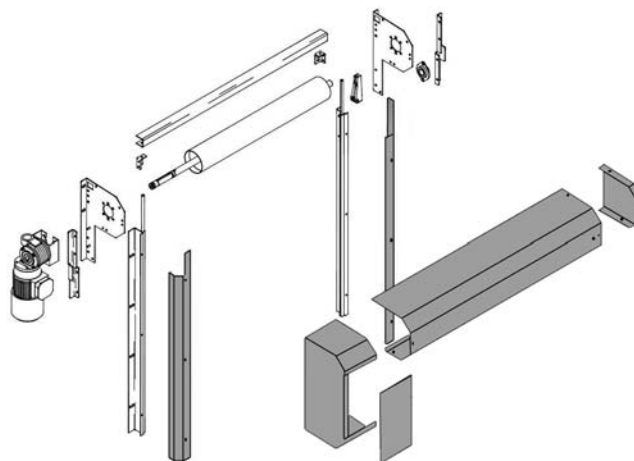



## 1.5 Operating system

### 1.5.1 General

The Albany HS8010P high speed door is always operated electrically. The operating system is a combination of an operator and a control unit. The operator opens and closes the door with an electric engine. The operator secures a safe closing speed with a soft start and stop.

### 1.5.2 Operator

Exceptional reliability and smooth operation is ensured by a motor driven by a frequency inverter. This technology ensures a soft start and stop, which increases the longevity of the motor considerably. It also allows faster opening/closing speed. This motor delivers reliable operations around-the-clock. The operator is always combined with a control unit.

The operator drives the fabric roll to open or close the door. In case of a main supply failure, the operator can be disconnected and the door can be opened or closed manually using the hand crank.

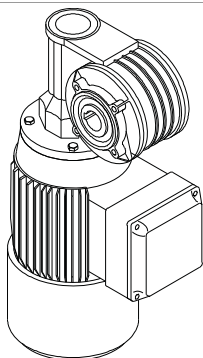

### 1.5.3 Door drive system

The high speed doors are equipped with a unique door drive system. This system eliminates the need for ballast in the door curtain or tension straps. This gear driven system consists of a pinion on the drive shaft that forces the lateral retaining straps up or down the tracks. This ensures that even under high pressure difference the door will be fully closed.

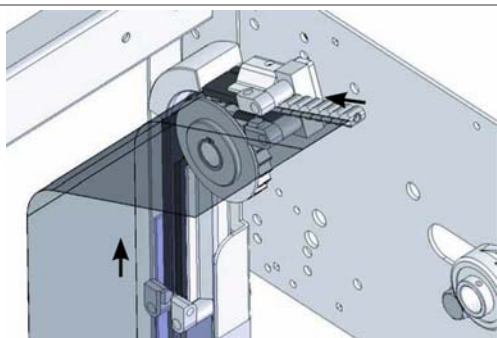

### 1.5.4 Control unit

The control unit is installed beside the door. It has impulse UP and DOWN buttons, an emergency stop mushroom button and a mechanical mains switch.

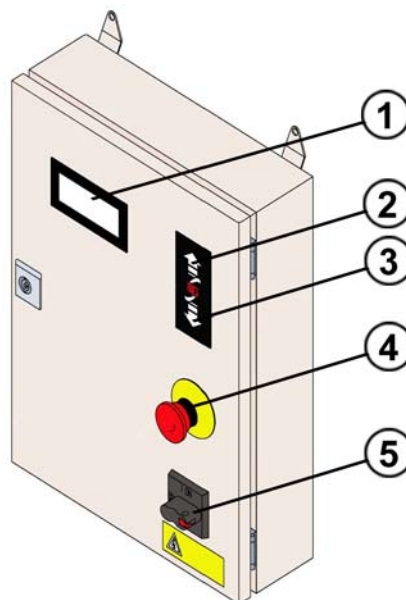

- 1) Display
- 2) UP button
- 3) DOWN button
- 4) Emergency stop
- 5) Mechanical main switch

### 1.5.5 Chain hoist

A chain hoist makes it possible to manually operate the door, e.g. during a power failure. When the electrical operation is in use, the chain hoist is disconnected. When manual operation is required, pulling a string will release the motor brake, allowing the drum to rotate freely, using the chain hoist.

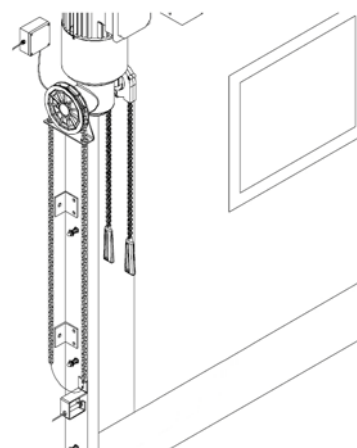

## 1.5.6 Access and automation

Albany offers a wide range of functions that allow advanced opening and safety control.

### 1.5.6.1 Basic control functions

#### Interlocking

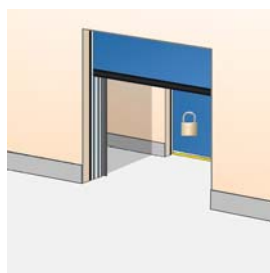

Developed for climate control or safety; If door A is open, door B cannot be opened. If door B is open, door A cannot be opened. An interlocked door can remember an up-command, if selected via a micro switch. Optionally an external locked switch can be installed to deactivate it.

- Function Interlock operating ( switch interlock ON/OFF delivered with priority door)
- Switch interlock on/off ( requires interlock function)
- Switch interlock on/off with key ( requires interlock function)

#### Airlock

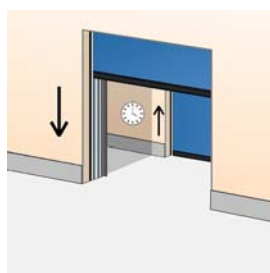

Developed for climate control or safety: Other than the interlock, door B will open automatically when door A is closed. Circuit card Installed in control unit. Optionally an external locked switch can be installed to deactivate it.

#### Reduced opening

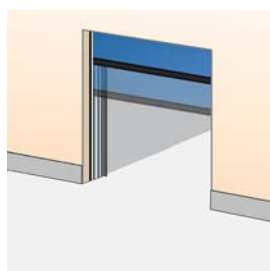

When people pass through the door, it may be unnecessary to fully open a door. A manual (pedestrian) command can trigger a reduced door opening, while a radar or magnetic loop still triggers a full door opening. Pre-fitted micro-switch to be activated in control unit.

- Function Two opening heights I/II with manual selection (switch included)
- Function Two opening heights I/II with automatic selection ( 2 different opening impulses)

### 1.5.6.2 External control functions

#### External push button box

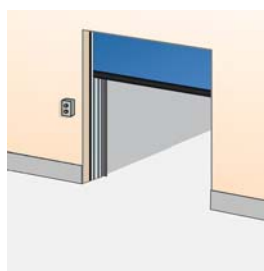

An extra control box is installed outside the building or inside close to the door if the main control unit needs to be installed away from the door opening. Usually combined with reduced opening. Installed on the inside or outside wall beside the door.

#### Pull-rope switch

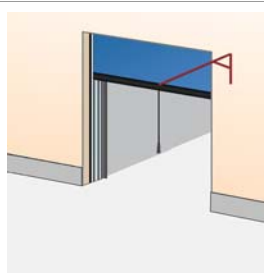

A pull-rope switch above the door opening can be operated from e.g. a forklift truck. Pulling the rope opens the door. Installed on the inside construction above the door.

- Pull down switch complete 5 m cord
- Pull switch bracket in galvanised steel – L 3000 mm
- Pull switch bracket in painted steel – L 3000 mm
- Pull switch bracket in stainless steel – L 3000 mm

#### Remote control



A hand-held radio transmitter allows door operation from a vehicle or any position within 50-100 meters from the receiver and aerial at the door. For closing, the door can be provided with a photocell beam. Receiver installed in control unit, antenna installed on the wall beside the door.

### 1.5.6.3 Automatic control functions

- Function Auto/Manual (includes switch on the control box)
- Function Manual closing with opening/closing using a common manual command (e.g. one single pull rope opens and closes the door)
- Function Manual closing with separate impulse (e.g. 2 buttons up and down)

#### Magnetic loop

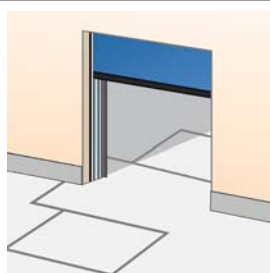

A sensor in the floor detects a metal object (usually forklift trucks, pallet trucks) and opens the door automatically. This is an ideal solution for frequent vehicle traffic. Installed on the outside, inside or both sides of the door in the floor.

#### Radar

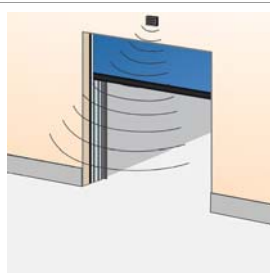

An infrared sensor above the door detects an object (person, vehicle) within a specified distance from the door and opens the door automatically. This is an ideal solution for frequent vehicle or personal traffic. Often combined with automatic closing. Installed on the inside or outside wall above the door.

#### Photocell open door

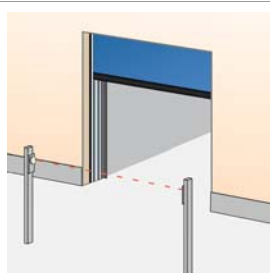

A set of photocells on pillars, on each side of the door. When a person or vehicle passes between the photocells, the beam is interrupted and the door opens. Photocells installed on pillars, away from the door.

#### Automatic closing (standard)

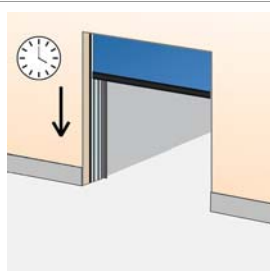

A programmable timer that closes the door after a specified time, counted from either the fully open position and/or from passing through the photocell beam. Usually also a switch on the control unit is used to turn to manual closing. Adjustable micro switches in control unit.

### 1.5.6.4 Safety functions

#### Wireless edge activator (standard)

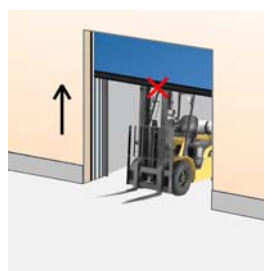

All doors are equipped with an edge activator. A wireless edge activator in the bottom seal detects any obstruction under a closing door and reverses the door. Installed in the bottom edge.

#### Safety photocells 1-channel (standard)

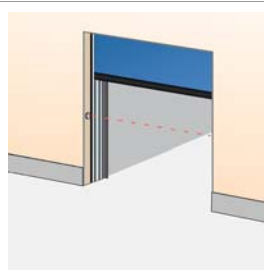

A set of a photocell transmitter and receiver is installed in the door opening. If the photocell beam is interrupted during closing, the door will stop in less than 30 mm and reverse to the fully open position. Installed in the door opening 300 mm from floor level.

#### Warning lights - Red

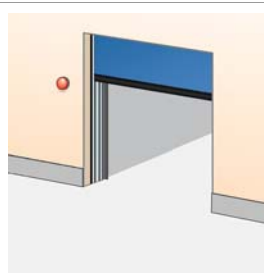

A red warning light on each side gives information on the current door behaviour. Flashing light seconds before and during door movement. Installed on the inside and outside wall beside the door.

#### Acoustic signal

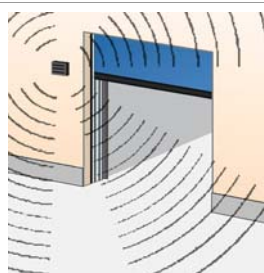

An acoustic signal is given, starting ...ms before the door begins to close and continues until the door is fully closed. Installed on the inside and outside wall beside the door.

- Acoustic signal 24VAC 80 dB at 1 meter ( horn when door is moving)

### 1.5.6.5 Lights

- Standard function flashing light
- Standard function flashing light with pre-warning before closing and opening

#### Warning lights - Orange

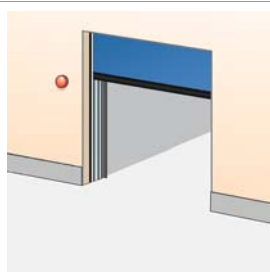

An orange warning light on each side gives information on the current door behaviour. Flashing light seconds before and during door movement. Installed on the inside and outside wall beside the door.

#### Warning lights - Green

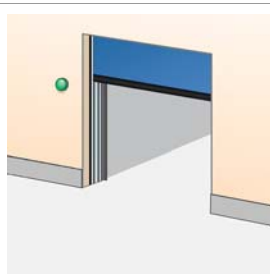

A green warning light installed on each side of the door indicating the open position of the door by continuous light signal.

#### Traffic lights - Red & Green

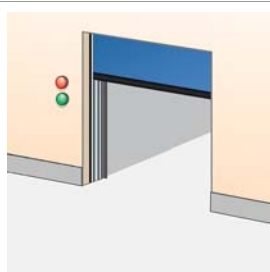

If traffic through a door needs to be directed; two red and two green traffic lights can be installed to indicate traffic direction. From the side where a vehicle is first detected to approach the door, the green traffic light comes on. The opposing side shows a red traffic light. Traffic from this direction must give way to the other. Usually installed in e.g. parking garages. Installed on the inside and outside wall beside the door.

### 1.5.6.6 Additional functions

#### UPS battery backup

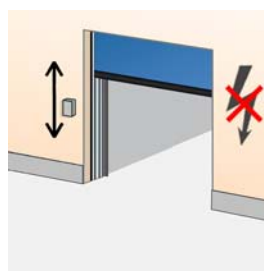

In case of main supply failure or emergency situations, it may be necessary to be able to open the door. The UPS battery stores enough power for one emergency opening cycle. Installed on the inside wall beside the door.

- Kit UPS Interface, automatic opening in case of power failure
- Kit UPS Interface, semi-automatic in case of power failure

### 1.5.7 Monitoring systems

As an option on all our products, a Monitoring System can be installed. This system helps to ensure efficiency and security in daily operations. All doors or docking stations are connected to the Monitoring System's server, which gives the opportunity to supervise, monitor and report a wide variety of aspects in a facility.



#### 1.5.7.1 Saving energy

A monitoring system reduces energy costs and contributes to a better environment. Energy is lost every time a door is open. If a door is open when no truck is at the bay, even more energy is lost.

A Monitoring System automatically ensures that no door will open unless there is a truck at the bay and even set it to close when there an activity is delayed.

#### 1.5.7.2 Security enhancement

Closing and locking doors is an obvious daily routine. However, checking this manually can be time consuming in a busy facility.

A Monitoring System can automatically ensure that all doors are closed and locked when they need to be. It can also activate all doors and locks from its remote location, and give a real-time overview of the building's situation.

#### 1.5.7.3 Dock management

A good way to increase throughput and thereby efficiency at a logistics facility is to reduce the time of having no truck – or the wrong truck – at a loading bay.

A Monitoring System makes visible – in real-time – which bays are occupied or free, and for how long. It makes it possible to reserve bays for docking activities and to inform drivers via SMS. Since it incorporates information from cameras and other inputs (RFID, card readers, etc.), the system stays updated in real-time.

#### 1.5.7.4 Facility management

The Monitoring System gives a real-time service status for all your door and docking equipment. If an error code occurs, the Albany service organisation is automatically notified, and will respond quickly. Other maintenance information can easily be integrated, further reducing the overall costs.

## 2. Specifications

**2.1 Daylight width and height** The standard Albany HS8010P high speed door is delivered in the following size range:

**Standard door sizes\***

	Daylight width	Daylight height
Min.:	1000 mm	2000 mm
Max.:	5500 mm	5500 mm

\* Other sizes may be available on request

### 2.2 Fabric specifications

	Coloured fabric	Vision panel
Material	Reinforced PVC	PVC
Thickness	0,8 mm	2,0 mm
Weight	900 g/m <sup>2</sup>	2,5 kg / m <sup>2</sup>
Tensile strength (kN/5cm)	4,0 L / 3,5 W	1,6
Tearing resistance	600 N (DIN 53363)	100 N (DIN 53515)

### 2.3 Windows

Dimensions: W x H: 640 mm x 580 mm.  
Combinations: Any combination of rows is possible.

#### 2.3.1 Required Daylight Width

DLW	Available no. of columns
1140 mm – 1929 mm	1
1930 mm – 2719 mm	2
2720 mm – 3509 mm	3
3510 mm – 4299 mm	4
4300 mm – 5089 mm	5

#### 2.3.2 Required Daylight Height

DLH	Available no. of rows	CC
2040 mm	1	1600 mm
2770 mm	2	2330 mm
3500 mm	3	3060 mm
3790 mm	4	3790 mm
4250 mm	5	4520 mm

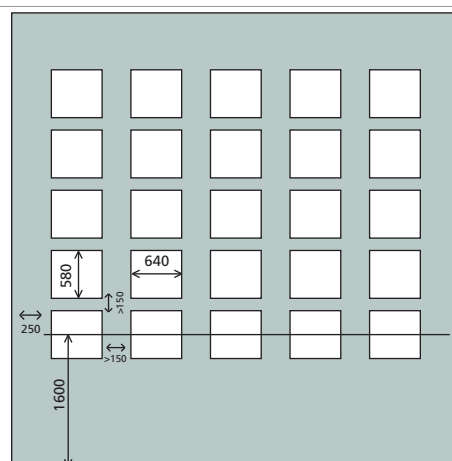

## 2.4 Vision panels

A vision panel can be installed at any DLW. At every 2200 mm DLW, the vision panel will be fitted with a vertical reinforcement strip. Vision panels are available in 400 mm and 800 mm height.

### 2.4.1 400 mm vision panel

Daylight Height	Available no. of vision panels	CC
< 1950 mm	1	1600 mm
≥ 2500 mm	2	2150 mm

### 2.4.2 800 mm vision panel

Daylight Height	Available no. of vision panels	CC
< 2150 mm	1	1600 mm
≥ 3100 mm	2	2550 mm

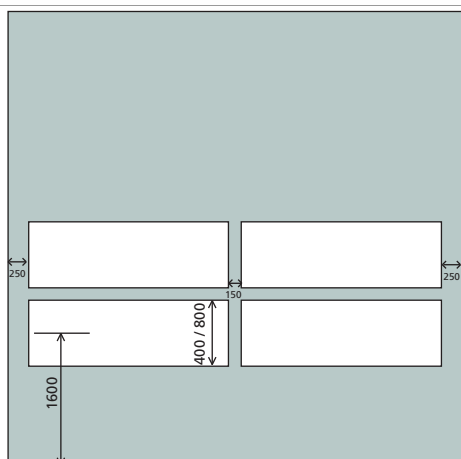

## 2.5 Large windows

Dimensions W x H: 1200 x 2400 mm. Only one row of these windows is possible.

DLW	Available no. of windows
≥ 1700 mm	1
≥ 3050 mm	2
≥ 4400 mm	3

Minimal required DLH = 2900 mm

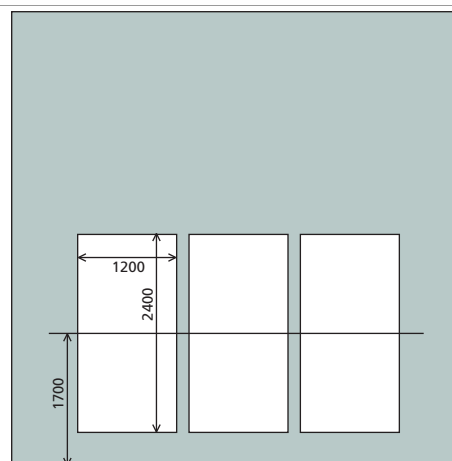

### 3. CEN Performance

Characteristic	Standard	Test acc.	Result	Value
Wind load	EN 12424	EN 12444	Class 3*	700 Pa (N/m <sup>2</sup> )
Water permeability	EN 12425	EN 12489	Class 2	50 Pa (N/m <sup>2</sup> ) water spray for 20 minutes
Air permeability	EN 12426	EN 12427	Class 1	24 m <sup>3</sup> /m <sup>2</sup> /h at 50 Pa
Safe openings	EN 12453	EN 12445	Pass	
Mechanical resistance	EN 12604	EN 12605	Pass	
Unintended movements	EN 12604	EN 12605	Pass	
Thermal resistance	EN 12428			6,02 W/(m <sup>2</sup> K)
Performance (cycles)	EN 12604	EN 12605	1.000.000 cycles	

\* Indicated wind-load classification is for maximum dimension. For doors up to W 4000 mm x H 5500 mm: Class 4 (1000 Pa (N/m<sup>2</sup>))



## 4. Building and space requirements

### 4.1 Building preparations

#### 4.1.1 Installation preparations

The door is pre-assembled in the factory as much as possible to ensure that installation can be carried out easily and quickly. The door is installed directly on the wall. A forklift truck is needed to raise the frame to the wall.

The fixation of the wall must be of an adequate strength to sustain the wind load as well as the blow of a collision.

#### 4.1.2 Electrical preparations

The following environment criteria and electrical supplies are required for the operator to function properly:

<b>Voltage supply:</b>	400V 3-phase
<b>Power:</b>	1,5 kW 3 x 16A
<b>Frequency:</b>	50Hz - 60Hz
<b>Degree of protection:</b>	Operator: IP65 Control unit: IP54
<b>Temperature working range:</b>	0 °C to +40 °C

## 4.2 Space requirements

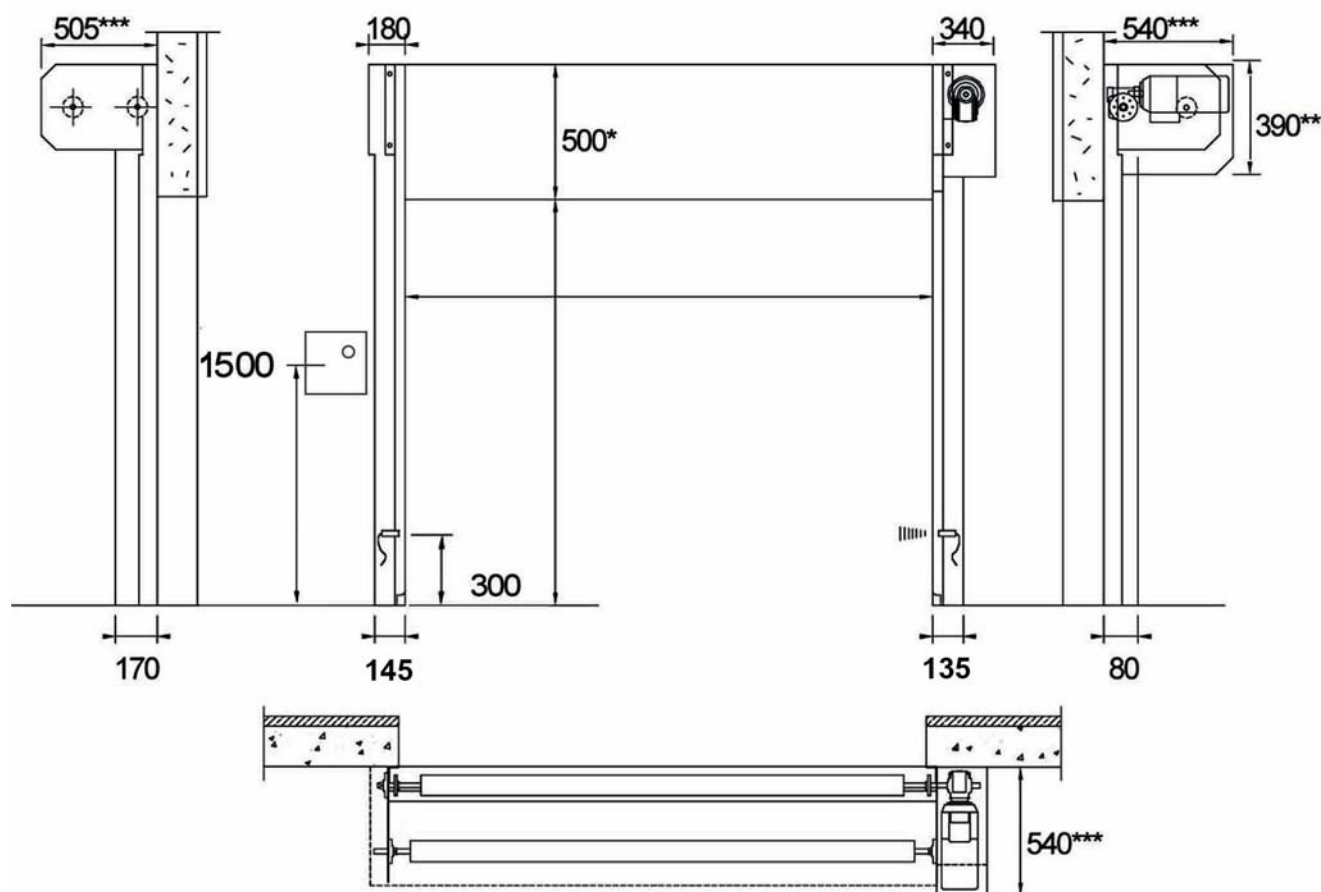

- \* If drum cover and  $H > 4000$  mm = 650 mm
- \*\* If drum cover and  $H > 4000$  mm = 600 mm
- \*\*\* If drum cover and  $H > 4000$  mm = 650 mm

### Reduced head room

The space requirement of the head room is 500 mm. This head room can be reduced to 370 mm if the door is max. 4000 mm high and is not equipped with a drum cover.

# 5. Service

## Preventive Maintenance Program and Modernization Services

As your entrances are part of your business flow, there's every reason to keep them working well. ASSA ABLOY Entrance Systems offers you a maintenance and modernization expertise to rely on. Our Maintenance Programs and Modernization Services are backed by a extensive expertise for all types of industrial door and docking systems, independent of brand. At your disposal is a team of dedicated expert technicians, proven through decades of maintenance, service and satisfied customers.

### Preventive Maintenance Programs

Minimizing lost time, lost energy and unexpected hassle is our team's constant objective. Our service organization can support you 24/7 in maintaining all industrial door and docking systems, independent of brand. If you want to be one step ahead of break-downs, explore our portfolio of Pro-Active Care plans. Naturally, we also offer entrance upgrades to suit your specific wishes and business needs.

### Pro-Active Care - Maintenance plans to fit your business

Regular maintenance can extend the lifetime of your equipment and help prevent unexpected problems. Our technician arrives on-site equipped with the knowledge and tools to service all automatic entrances, independent of brand.

- **Pro-Active Bronze**

The base on which all Pro-Active Plans are built provides the security of knowing that your equipment is regularly inspected and certified for safety, as well as performing optimally. It includes a number of planned on-site visits depending on your needs. Any unplanned service calls required during the term of the contract (including labor, travel and parts) are billed at special Pro-Active Care prices.

- **Pro-Active Silver**

This plan provides all the benefits of Pro-Active Bronze with the added advantage of labor and travel being included for service calls during regular business hours. The only additional charge would be for any parts that may be needed throughout the term of the contract.

- **Pro-Active Gold**

This plan provides the ultimate protection for your automatic entrance investment. It includes all the benefits of Pro-Active Silver, plus replacement of any parts required during an unplanned repair or planned maintenance visit. Pro-Active Gold is an excellent way to budget your automatic door expenses annually.

- **Pro-Active Tailor-Flex**

Our most flexible maintenance and service offering. The Pro-Active Care plan is designed by you, our customer. The plan allows you to balance your maintenance expenses against your real-world budget and presents the option to add or delete a number of maintenance elements to suit your budget goals, while meeting your overall performance and safety needs.

### Modernization

Your entrances are a long-term investment, from which you always want the best. Products develop over time, so do regulations and your business. Let us help you increase energy savings and meet today's standards. We provide advice and modernization kits for outdated installations, ensuring your investment meet requirements and performs optimally for many more years to come.

Re-Active Service		Pro-Active Care				
Corrective	SafetyCheck	Pro-Active Bronze	Pro-Active Silver	Pro-Active Gold	Pro-Active Tailor Flex	
		○	○	○	●	Other customized requests such as Response Time, Performance InfoPack and Advanced User Training
		○	○	●	○	Replacement of worn parts according to preventive Consumable Exchange Program
		○	○	●	○	Replacement of spare parts on breakdowns
		○	●	●	○	Travel and labor for additional call-out visits
		●	●	●	●	Preventive maintenance visits 1-4 times per year
		●	●	●	●	Travel and labor for preventive maintenance visits
		●	●	●	●	Response time and priority on call-outs <24h
		●	●	●	●	Preventive planned maintenance that meets the most demanding standards in the market
	●	●	●	●	●	Safety and quality checks according to applicable regulations and norms. Documentation of test results provided
●	●	●	●	●	●	Documentation of equipment status, assessment and service provided, all generated on site
●	●	●	●	●	●	Highly trained professional technicians with extensive knowledge, state-of-the-art tools and the right spare parts*
●	●	●	●	●	●	Dedicated Professional Customer Care Hotline

● = Included as standard

○ = Available at special prices

\* Well-stocked service vehicles with genuine and new spare parts

# Index

## Numerics

400 mm vision panel .....	15
800 mm vision panel .....	15

## A

Access and automation .....	10
Acoustic signal .....	11
Additional functions .....	12
Airlock .....	10
Automatic closing (standard) .....	11
Automatic control functions .....	11

## B

Basic control functions .....	10
Bottom edge .....	7
Building and space requirements ...	17
Building preparations .....	17

## C

CEN Performance .....	16
Chain hoist .....	9
Colours .....	7
Construction .....	6
Control unit .....	9
Copyright and Disclaimer Notice .....	2
Covers .....	8

## D

Daylight width and height .....	14
Description .....	6
Dock management .....	13
Door curtain .....	6
Door drive system .....	9

## E

Electrical preparations .....	17
External control functions .....	10
External push button box .....	10

## F

Fabric roll .....	8
Fabric specifications .....	14
Facility management .....	13
Features .....	3

## G

General .....	6, 8, 9
---------------	---------

## H

Header box .....	8
------------------	---

## I

Installation preparations .....	17
Insulated door curtain .....	7
Interlocking .....	10

## L

Large windows .....	15
Lights .....	12

## M

Magnetic loop .....	11
Material .....	6
Monitoring systems .....	13

## O

Operating system .....	9
Operator .....	9
Options .....	6

## P

Performance .....	3
Photocell open door .....	11
Pull-rope switch .....	10

## R

Radar .....	11
Reduced opening .....	10
Remote control .....	10
Required Daylight Height .....	14
Required Daylight Width .....	14

## S

Safety functions .....	11
Safety photocells 1-channel (standard)	11
Saving energy .....	13
Security enhancement .....	13
Self repair system .....	7
Service .....	19
Side columns .....	8
Space requirements .....	18
Specifications .....	14
Standard .....	6

## T

Technical facts .....	3
Traffic lights - Red & Green .....	12

## U

UPS battery backup .....	12
--------------------------	----

## V

Vision panels .....	15
---------------------	----

## W

Warning lights - Green .....	12
Warning lights - Orange .....	12
Warning lights - Red .....	11
Wind reinforcement .....	8
Windows .....	14
Windows and vision panels .....	7
Wireless edge activator (standard)	11







ASSA ABLOY Entrance Systems is a leading supplier of entrance automation solutions for efficient flow of goods and people. With our globally recognized product brands Besam, Crawford, Megadoor and Albany, we offer products and services dedicated to satisfying end-user needs for safe, secure, convenient and sustainable operations.  
ASSA ABLOY Entrance Systems is a division within ASSA ABLOY.

**ASSA ABLOY**

[assaabloyentrance.com](http://assaabloyentrance.com)

Q1.0 - 2015



ASSA ABLOY Entrance Systems

[assaabloyentrance.com](http://assaabloyentrance.com)